

USER'S MANUAL



Compressor Nebulizer



Unit 11 . 3/F . Tower A . New Trade Plaza
6 On Ping Street . Shatin . Hong Kong
Tel. +852-26352285
info@kaiyamed.com

www.kaiyamed.com

Model

KYWH1001 / KYWH2001

Content

Important Safeguards.....	3
Intended Use.....	4
Description of the device.....	4
Technical Specifications.....	4
Symbols.....	5
Checklist for unpacking.....	6
Operating instructions.....	6
Cleaning.....	7
Maintenance	7
Troubleshooting.....	7

Cleaning

NOTE: Clean the Nebulizer compressor after every use and at least once a day.

1. Turn the power off and unplug from the wall outlet.
2. Remove the tubing from the air inlet.
3. Disassemble mouthpiece or mask from cap. Open nebulizer compressor by turning cap counterclockwise and removing baffle.
4. Wash all items, except tubing, in a hot water/dishwashing detergent solution. Rinse under hot tap water for 30 seconds to remove detergent residue. Allow to air dry.
5. For reusable nebulizer compressor only, clean daily in dishwasher using top shelf.

Maintenance

1. The filter of air compressor should be replaced when it turns grey. Additional filter can be purchased from the dealer or pharmacy that you purchased the device from.
2. A certified technician should make repairs only.

Troubleshooting

Nebulizer compressor doesn't operate	Check if plug is properly installed in an appropriate electrical outlet.
Nebulization is weak	Check if fuse is properly situated. Safety Device is overheated or has run continuously for more than 30 minutes. Leave power off for 30 minutes before next usage. If nebulizer still doesn't operate, contact dealer.
Blockage	Check if tubing is blocked. If so, unblock or replace.
Air leakage	Check if medication cup is firmly attached to compressor. If there is still air leakage after reconnection, replace the tubing.
Damage	Check if medication cup or tubing is damaged. If so, replace damaged medication cup and/or tubing.
Baffle seated	Check if nebulizer baffle is properly seated in the medication cup. If not, re-seat.
Dirty filter	Check if filter is dirty or gray. If so, replace.

Checklist for unpacking

Before using this product, make sure you have the following items:

- 1 User's manual
- 1 Nebulizer set
- 1 Air compressor unit

Operating instructions

1. Place compressor on a table, sturdy and flat surface such that the unit can be easily reached when you are seated.
2. Pull out the power cord from the base of the unit and make sure that the unit is in the "OFF" (O) position by pressing on the left side of the switch.
3. Plug the power cord into the wall outlet according with your local voltage.
4. Connect one end of the nebulizer tubing into the air inlet connector.
5. Add the prescribed medication through the opening on cap using an eyedropper or pre-measured dose container.
6. Assemble mouthpiece and T-piece and insert into the top of the nebulizer cap. If an aerosol mask is used, connect the bottom of the mask to the top of the nebulizer cap.
7. Connect the tubing to nebulizer air inlet connector.
8. Turn the power on to start the unit.
9. Implement the treatment by placing the mouthpiece between the teeth. Inhale and exhale through the mouthpiece.
10. If aerosol mask is used, place mask over the mouth and nose.

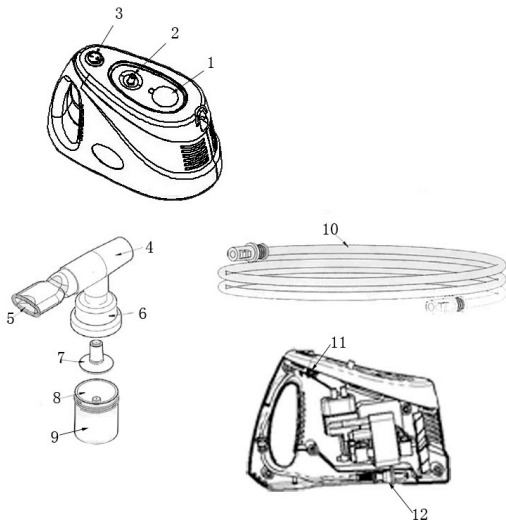

1. Filter Cap
2. Air Inlet Connector
3. Power Switch
4. Nebulizer T-Piece
5. Mouthpiece
6. Nebulizer T-Piece
7. Baffle
8. Air Inlet Connector
9. Nebulizer Chamber
10. Tubing
11. Fuse
12. Power Cord

Kaiya Use's Manual

Important Safeguards



CAUTION: To reduce the risk of electrocution:

- Always unplug unit immediately after use.
- Do not use while bathing.
- Do not place or store the unit where it can fall or be pulled into a tub or sink.
- Do not place or drop into water or other liquid.
- Do not reach for a product that has fallen into water. Unplug immediately.



WARNING: To reduce the risk of burns, electrocution, fire, or injury to persons.

- Do not remove the cabinet or open the cover.
- Disconnect the power cord from the electrical outlet before cleaning or servicing.
- Do not place this equipment near hot, sparking or burning objects.
- Turn the unit off when it is not in use.
- Keep the cord away from heated or hot surfaces.
- Never drop or insert any object into any opening.
- Never block the air opening of the product or place it on a soft surface, such as a bed or couch where the opening may be blocked.
- Avoid the operation in wet or damp locations.
- Unplug the unit before filling the nebulizer.

Kaiya Use's Manual

Intended Use

The Compressor Nebulizers KYWH1001 and KYWH2001 are intended for use in the treatment of asthma, Chronic Obstructive Pulmonary Disease (COPD) and other respiratory ailments in which an aerosol medication is required during therapy. They are suitable for single patient use. The KYWH1001 and KYWH2001 Nebulizer are not intended for life support nor does it provide any patient monitoring capabilities

Description of the device











This compact, portable and light-weight nebulizer offers convenience while receiving inhalation treatments. Treatments are delivered quickly, safely and conveniently making this unit ideal for all ages. It uses an oil free, piston pump to create air pressure.

Technical Specifications

Electrical Requirements:	115Vac/60Hz; 220Vac/60Hz
Power Consumption:	75VA
Dimensions:	250mm(H)x125mm(w)x170mm(L), 9.8"(H)x4.9"(W)x6.7"(D)
Fuse:	F6AL250V
Classification:	Class II equipment, Type B applied part.
Operation Mode:	Intermittent operation, 30Min. ON / 30Min. OFF
Weight:	1.55 Kg.(3.42 Lb)
Sound Level:	<58 db (A)
Maximum Pressure:	2.41bar (35psi)
Operating Pressure:	0.76bar (11psi)
Flow Range:	<9 lpm (0.318cfm)
Operation Humidity Temperature:	5°C(41°F) to 40°C(104°F) 30% to 95%RH
Storage Humidity Temperature:	- 40°C(-40°F) to 70°C(158°F) 10%to100%RH
Atmospheric Pressure Range For Carriage And Storage:	50~106 kpa (7.3~15.4 psi)
Particle Size:	Less than 5 microns

NOTE: Conditions may vary based on altitude, barometric pressure and temperature. Specification subject to change without notice.

Symbols

	General warning, caution, risk of danger Please read the instructions carefully before operating the product.
	"ON" (power)
	"OFF" (power)
	Type B applied part Note: B = Body
	Class II equipment
SN	Manufacture's serial number
	Date of manufacture
	Manufacture
	FRAGILE, Contents of the transport package are fragile therefore it shall be handled with care.
	THIS WAY UP Indicates correct upright position of the transport package.
	KEEP AWAY FROM RAIN Transport package shall be kept away from rain.